



## Catálogo de Productos



BEIJING HUADE HYDRAULIC INDUSTRIAL GROUP CO.,LTD.	Meter-in pressure compensator, direct operated, Type ZDC			RE 24750/06.2004
	Size 10.16.32	up to 35 MPa	up to 325 L/min	Replaces:

**Features:**

- Load compensation in port P to A or P to B via a built-in shuttle valve
- 2-way version "P"
- 3-way version "P T" (NS10-25)
- Flow control when working together with a proportional directional valve



**Function, section**

The ZDC... valves are direct operated meter-in pressure compensators of 2 or 3-way design. They are used for the load compensation as a meter-in pressure compensator in channel P. These valves basically consist of the housing (1), the control spool (2), compression spring (3) with spring washer (4) and the cover (5) with integrated shuttle

valve (6). The compression spring (3) holds the control spool (2) in the open position from P1 to P, when the pressure differential P1 to A1 or P1 to B1 is less than 1.0 MPa. If the pressure differential exceeds 1.0 MPa, then the control spool (2) is moved to the left until the pressure differential is restored.

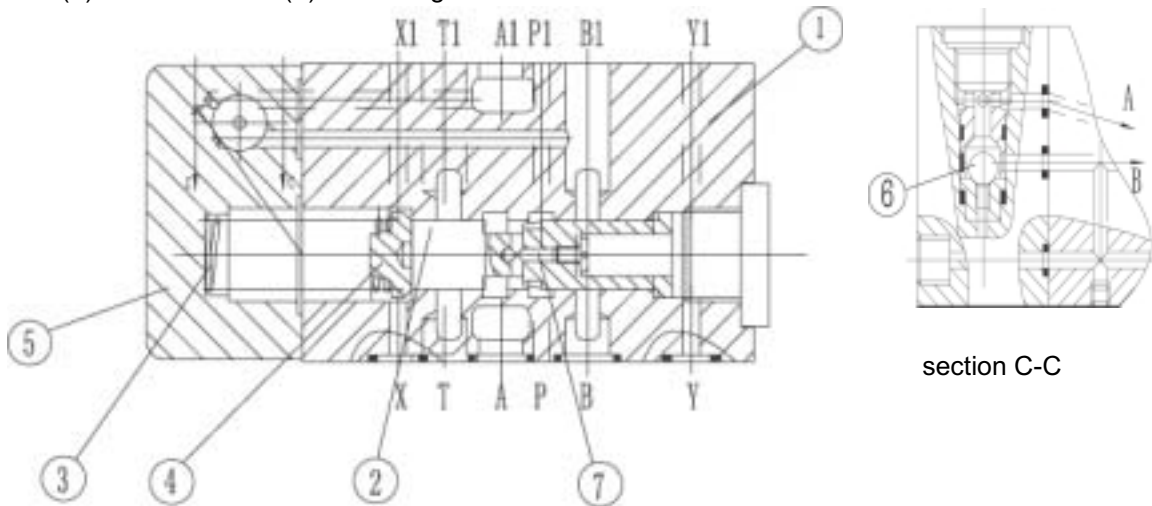

Type ZDC (NS 10)

**Symbols**

Pilot oil supply  
"internal"

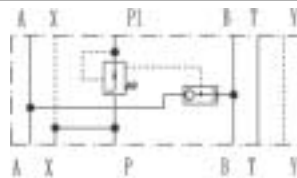

Type ZDC...P-20B/...

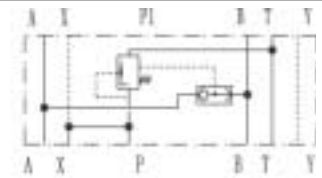

Type ZDC...PT-20B/...

Pilot oil supply "external", port X  
is closed on the valve side (only  
NS10)

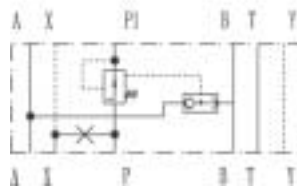

Type ZDC...P-20B/X...

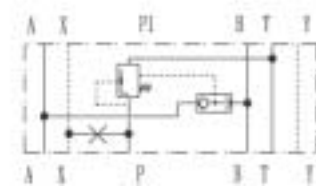

Type ZDC...PT-20B/X...

## Pilot oil supply

For internal pilot oil supply for the proportional valve and the meter-in compensator, the oil is taken from the throttling point in the compensator. Port X is then plugged.

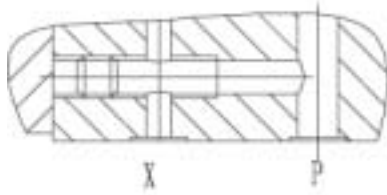

Pilot oil supply internal

With external pilot oil supply, the connection in port p is closed. The pilot oil is supplied by a separate control circuit.

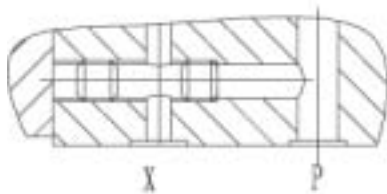

Pilot oil supply external

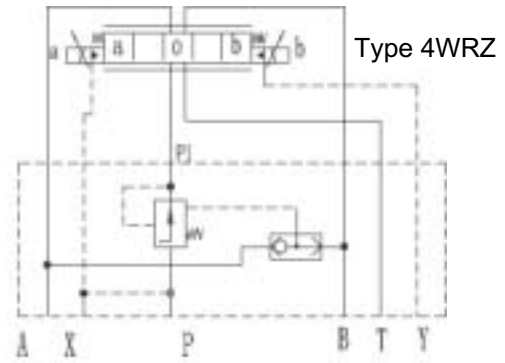

Type ZDC . . . P . . . 20B/ . . .

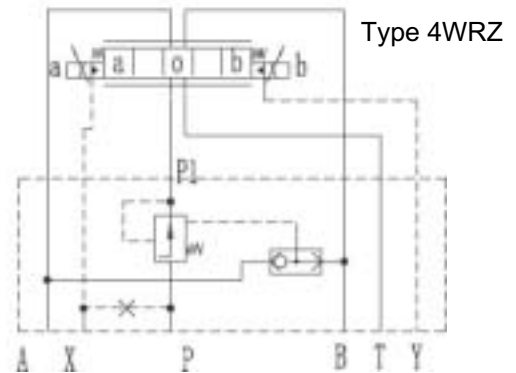

Type ZDC . . . P . . . 20B/X . . .

## Ordering code

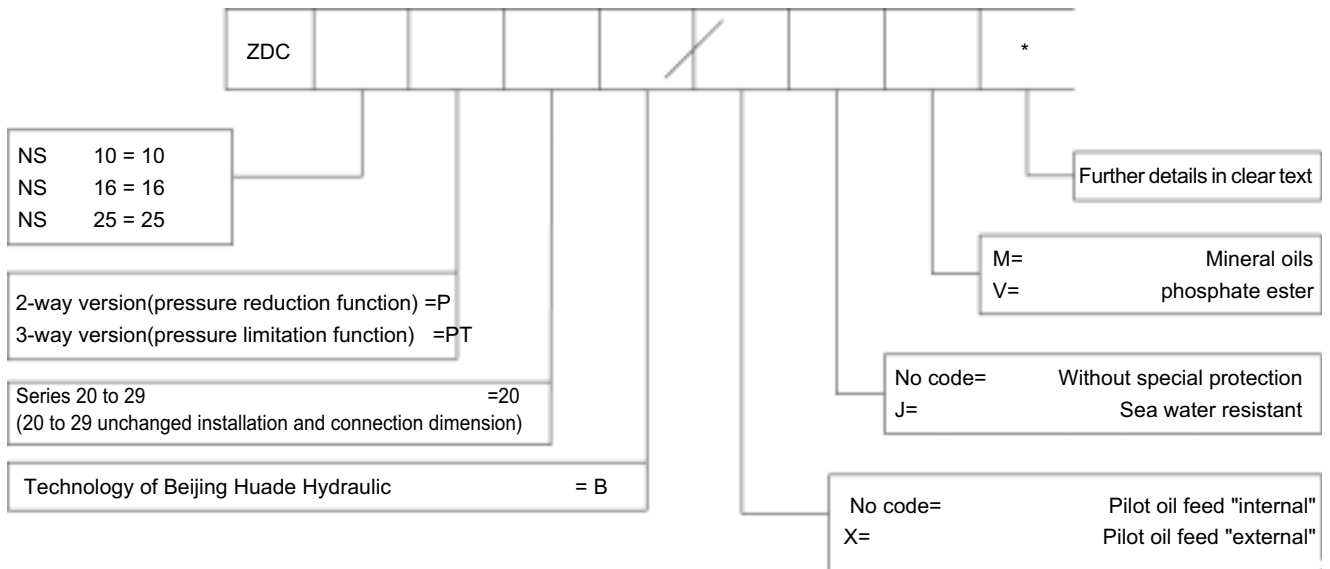

size		10	16	25	others is the same as the valves having same dimension
flow (L/min)		85	150	325	
weight (Kg)		3	3.5	8.9	
Operating pressure (MPa) P <sub>max</sub>	A, B, P	35			
	T	25			
	X	3 to 10			
	Y	up to 3, (Only when be used with the port operated proportional direction valve, otherwise 15)			
Degree of containsnation (μm)		≤ 20(recommend 10)			

**Characteristic curves (measured at V = 41 mm<sup>2</sup>/s and t = 50°C )**

ZDC10:

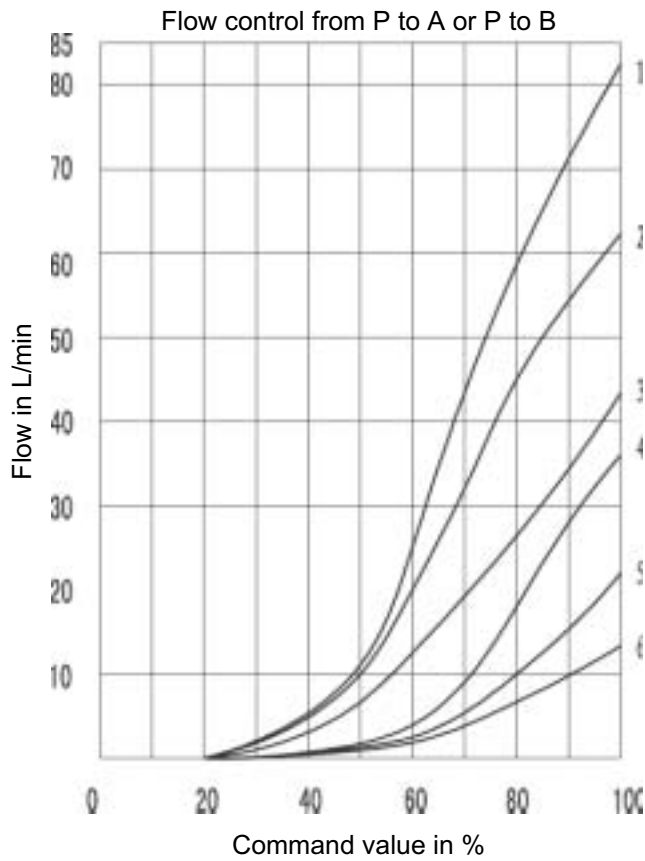

- 1= With valve type 4WRZ10...50-30B/6A.../...
- 2= With valve type 4WRZ10...50-30B/6A.../...
- 3= With valve type 4WRZ10...25-30B/6A.../...
- 4= With valve type 4WRA10...40-10B/...Z4/...
- 5= With valve type 4WRA10...20-10B/...Z4/...
- 6= With valve type 4WRA10...10-10B/...Z4/...

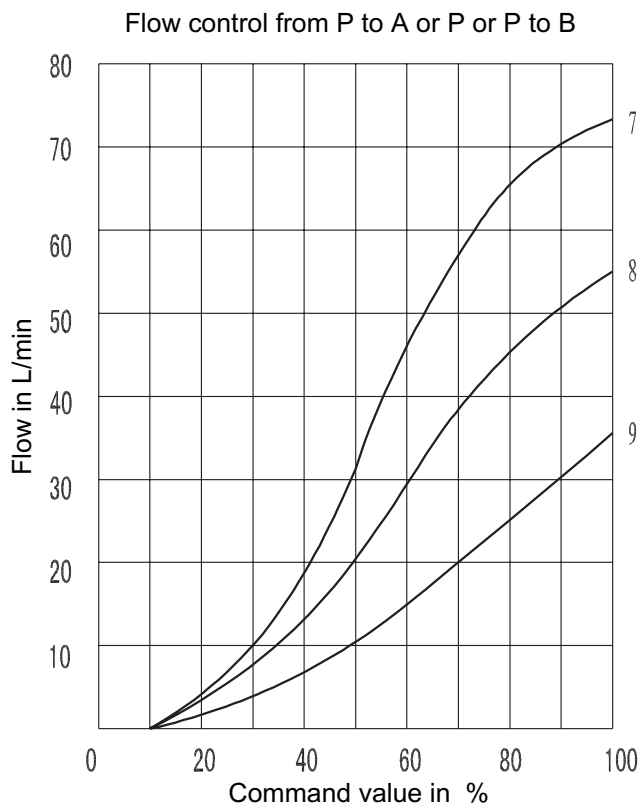

- 7= With valve type 4WRE10...64-10B/24Z4/...
- 8= With valve type 4WRE10...32-10B/24Z4/...
- 9= With valve type 4WRA10...16-10B/24Z4/...

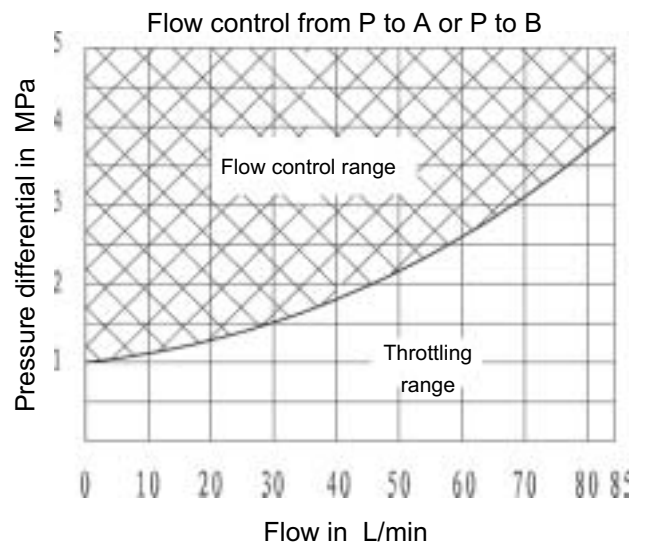

**Characteristic curves (measured at  $V = 41 \text{ mm}^2/\text{s}$  and  $t = 50^\circ\text{C}$ )**

ZDC16: 1= with valve type 4WRZ16...100-30B/6A.../...  
 2= with valve type 4WRZ16...150-30B/6A.../...

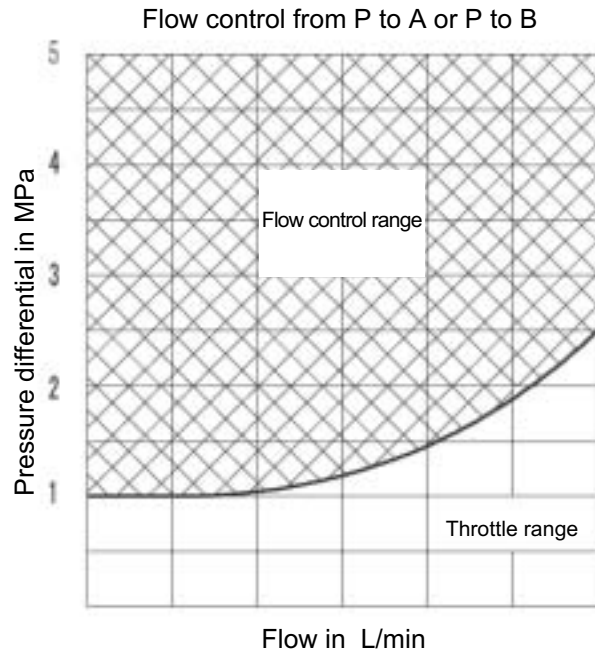
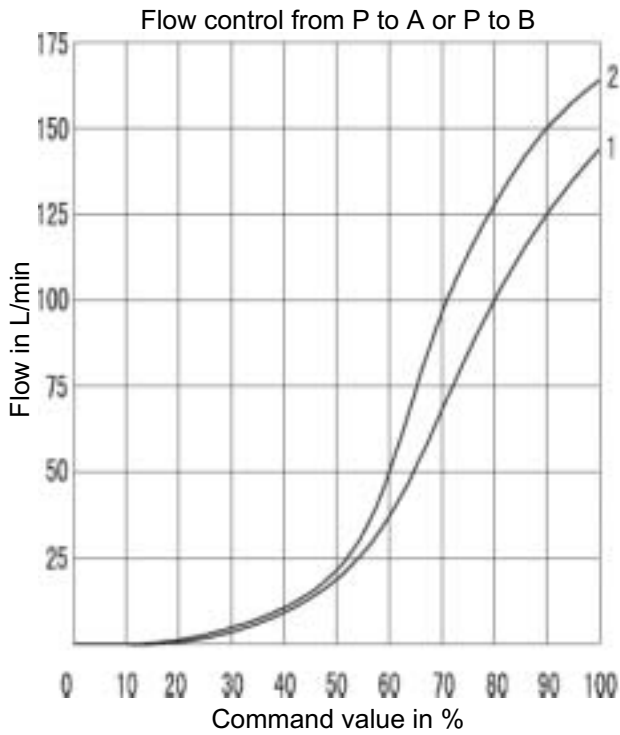

ZDC25: 1= with valve type 4WRZ25...270-30B/6A.../...  
 2= with valve type 4WRZ25...325-30B/6A.../...

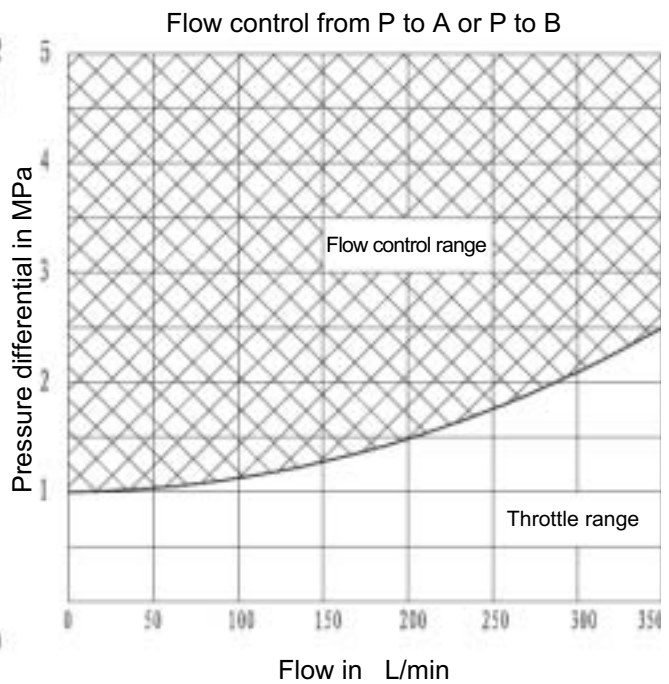
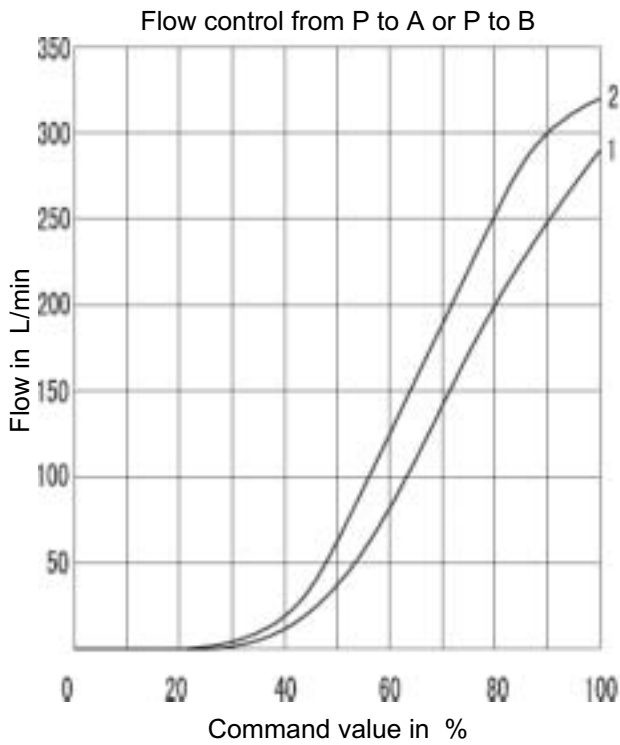

ZDC10:

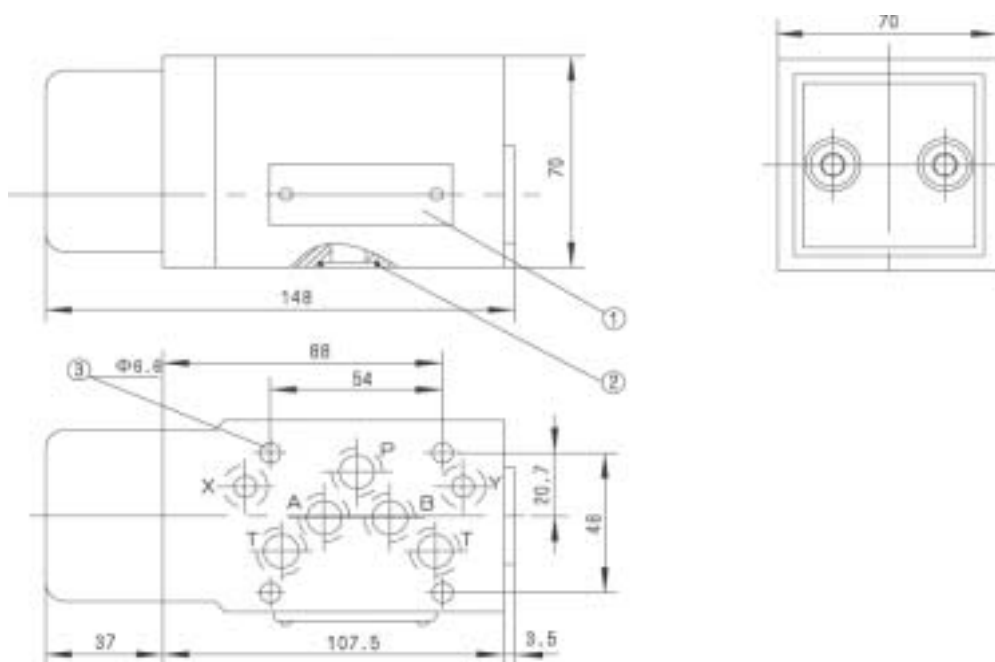

1. Nameplate
2. O-ring 12x2 for ports A,B,P,T
3. Valve fixing screw holes

ZDC16:

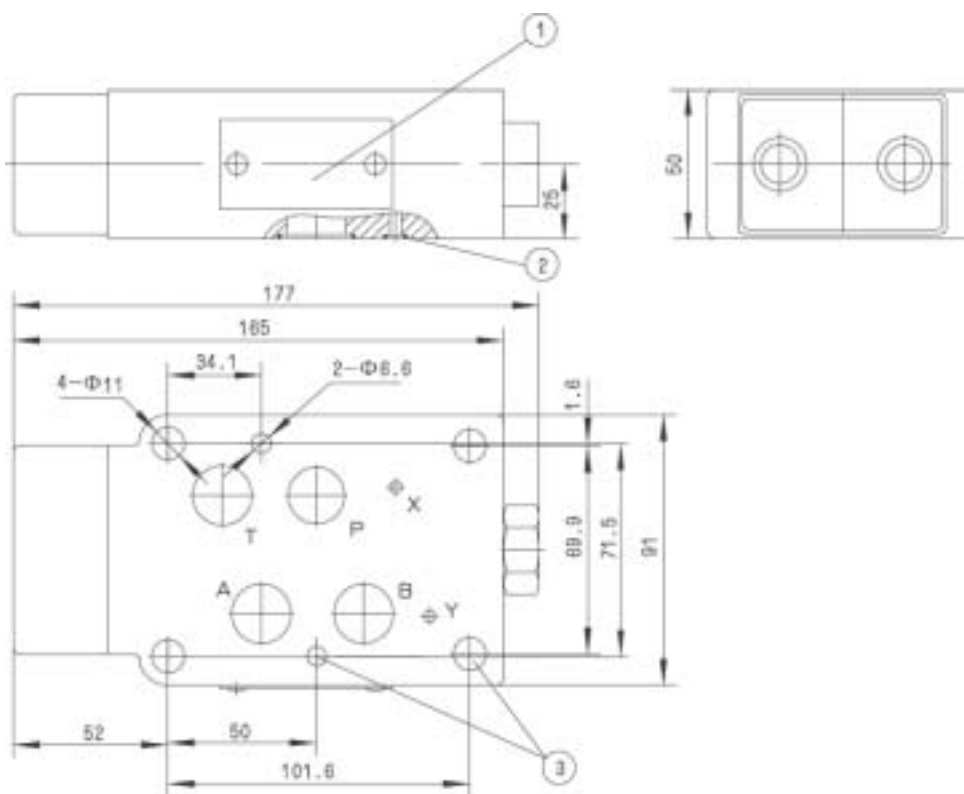

**Unit Dimensions:**

**(dimensions in mm)**

1. Nameplate
2. O- rings 22x2.5 for port A,B,P,T
3. Valve fixing screws

ZDC25:

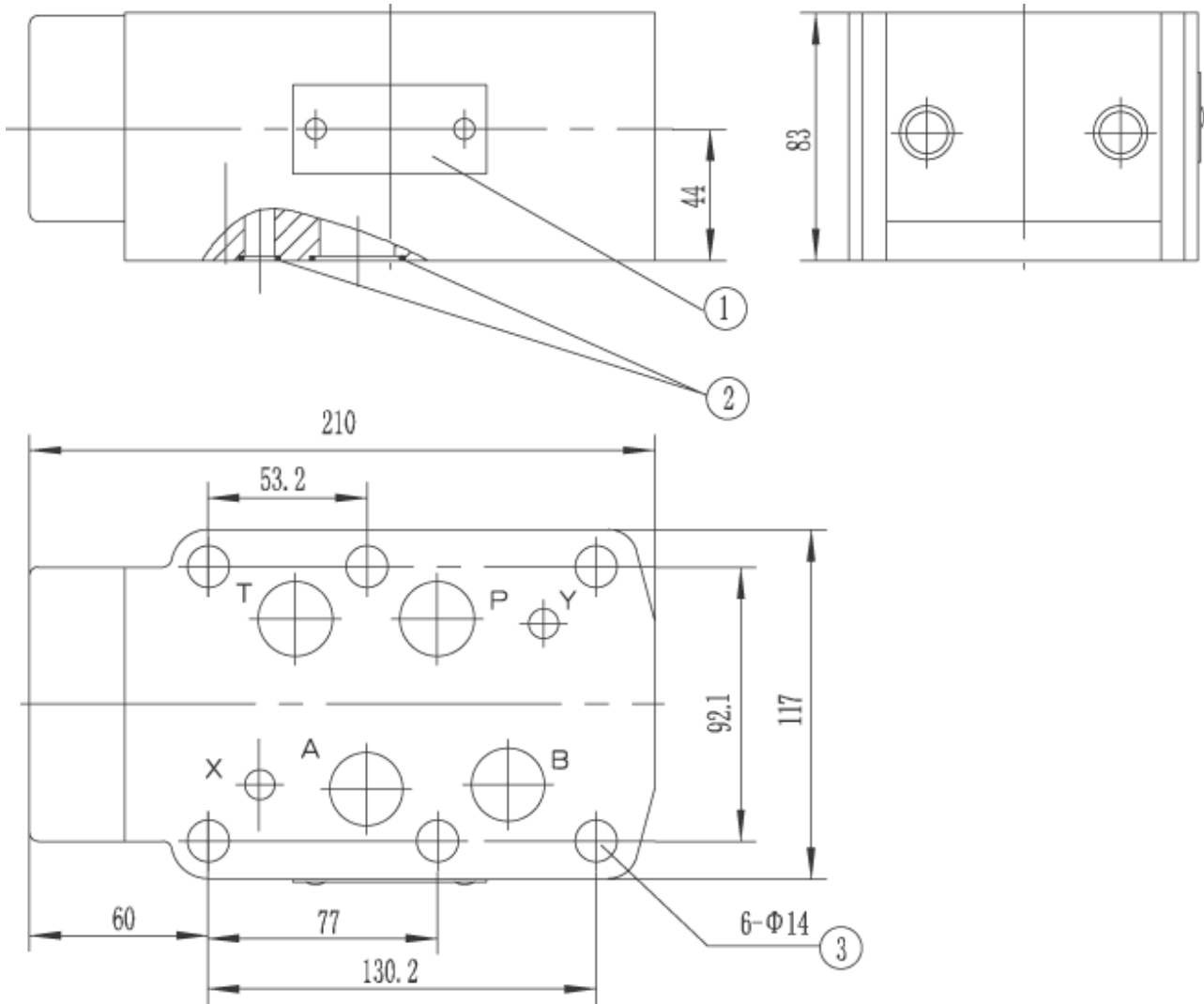

1. Nameplate
2. O-rings 27x3 for ports A,B,P,T  
O-rings 19X3 for ports X,Y
3. Valve fixing screws

## NOTICE

1. The fluid must be filtered. Minimum filter fineness is 20  $\mu\text{m}$ .
2. The tank must be sealing up and an air filter must be installed on air entrance.
3. Products without subplate when leaving factory, if need them, please ordering specially.
4. Valve fixing screws must be high intensity level (class 10.9). Please select and use them according to the parameter listed in the sample book.
5. Roughness of surface linked with the valve is required to .
6. Surface finish of mating piece is required to 0.01/100mm.

ANNOTATIONS :

---

---

---

---

---

---

---

---

---

---

---

---

---

---

---

---

---

### HUADE AMÉRICA

CEP: 03162-020

RUA HIPÓDROMO 1445 – MOOCA, SÃO PAULO, SP, BRASIL

TEL: (11) 3186-5959

huade@huade.com.br

www.huade.com.br